

# Liquefield\_Petroleum\_Gas\_\_Bas ed\_on\_Atmega\_16\_Microcontroll er.pdf

*by*

---

FILE	LIQUEFIELD_PETROLEUM_GAS__BASED_ON_ATMEGA_16_MICROCON TROLLER.PDF (766.01K)	WORD COUNT	4739
TIME SUBMITTED	25-DEC-2020 06:21PM (UTC+0700)	CHARACTER COUNT	22493
SUBMISSION ID	1481210680		

5 See discussions, stats, and author profiles for this publication at: <https://www.researchgate.net/publication/324553905>

4 **Early Leakage Protection System of LPG (Liquefied Petroleum Gas) Based on ATmega 16 Microcontroller**

15 Article in *IOP Conference Series Materials Science and Engineering* · April 2018  
 DOI:10.1088/1757-899X/336/1/012021

CITATIONS  
2

READS  
525

6 authors, including:

 **SRIWATI .ST.MT**  
 UNIVERSITAS ISLAM MAKASSAR  
 5 PUBLICATIONS 2 CITATIONS  
[SEE PROFILE](#)

 **Andani Achmad**  
 39 PUBLICATIONS 58 CITATIONS  
[SEE PROFILE](#)

Some of the authors of this publication are also working on these related projects:

-  **Real-time and continuous output power monitoring of photovoltaic (PV) systems** [View project](#)
-  **Conference AEMT** [View project](#)

PAPER • OPEN ACCESS

## 4 Early Leakage Protection System of LPG (Liquefied Petroleum Gas) Based on ATmega 16 Microcontroller

12  
To cite this article: Sriwati *et al* 2018 *IOP Conf. Ser.: Mater. Sci. Eng.* **336** 012021

View the [article online](#) for updates and enhancements.

### 1 Related content

- 4  
- [Kinetic modeling of liquefied petroleum  
13s \(LPG\) reduction of titania in MATLAB](#)  
Tan Wei Yin, Sivakur<sup>1</sup>, Ramakrishnan,  
Sheikh Abdul Rezan *et al.*
- [LPG as a Fuel for Diesel Engines-  
Experimental Investigations](#)  
Nikolaos Cristian Nutu, Constantin Pana,  
Niculae Negurescu *et al.*
- 9  
- [Laser ignition of liquid petroleum gas at  
elevated pressures](#)  
E Loktionov, N Pasechnikov and V Telekh



**IOP | ebooks™**

Bringing you innovative digital publishing with leading voices  
to create your essential collection of books in STEM research.

Start exploring the collection - download the first chapter of  
every title for free.

## 4 Early Leakage Protection System of LPG (Liquefied Petroleum Gas) Based on ATmega 16 Microcontroller

Sriwati<sup>1\*</sup>, Nur Ikhsan Ilahi<sup>2</sup>, Musrawati<sup>3</sup>, Syarifuddin Baco<sup>4</sup>, Ansar Suyuti<sup>5</sup>, Andani Achmad, Ejah Umrianah<sup>5</sup>

<sup>1,2</sup>Electrical Engineering, <sup>3</sup>Industri Engineering, <sup>4</sup> Informatic Engineering of Makassar Islamic University, <sup>5</sup>Electrical Engineering of Hasanuddin University. Perintis Kemerdekaan Street Km.9 No.29 Makassar

\*sriwati.dty@uim-makassar.ac.id

**Abstract.** LPG (Liquefied Petroleum Gas). LPG is a hydrocarbon gas production from refineries and gas refinery with the major components of propane gas (C<sub>3</sub>H<sub>8</sub>) and butane (C<sub>4</sub>H<sub>10</sub>). Limit flame (Flammable Range) or also called gas with air. Value Lower Explosive Limit (LEL) is the minimum limit of the concentration of fuel vapor in the air which if there is no source of fire, the gas will be burned. While the value of the Upper Explosive Limit (UEL), which limits the maximum concentration of fuel vapor in the air, which if no source of fire, the gas will be burned. Protection system is a defend mechanism of human, equipment, and buildings around the protected area. Goals to be achieved in this research are to design a protection system against the consequences caused by the leakage of LPG gas based on ATmega16 microcontroller. The method used in this research is to reduce the levels of leaked LPG and turned off the power source when the leakage of LPG is on the verge of explosive limit. The design of this protection system works accurately between 200 ppm up to 10000 ppm, which is still below the threshold of explosive. Thus protecting the early result of that will result in the leakage of LPG gas.

17

### 1. Introduction

LPG (Liquefied Petroleum Gas). LPG is a hydrocarbon gas production from refineries and gas refinery with the major components of propane gas (C<sub>3</sub>H<sub>8</sub>) and butane (C<sub>4</sub>H<sub>10</sub>). At atmospheric pressure, a gaseous LPG, but for ease of distribution, LPG converted to a liquid phase by applying pressure. In liquid form, LPG is distributed in tubes or tanks.

LPG gas is in the tube in a liquid state and partly intangible steam. The ratio between the volumes of gas when evaporating gas in the liquid state varies depending on the composition, pressure and temperature, but is typically around 250: 1. The ability of the gas could be transformed into liquid is an excess of material that is gas volume can be reduced. Excess is applied mainly to store and deliver gas in the tank, which in this way is economically very profitable.

Limit flame (Flammable Range) or also called burst limit (Explosive Range) is the ratio of the mixture (in percentage) between the gas with air, where in that range may occur fire or explosion. To be able to fire or occur explosion, the magnitude of the ratio between gas vapor and air does not have a single value (number), but the values that have a lower limit and upper limit.

So if there is a mixture of gas and air in the range bottom and top value, there will be a fire or explosion. Lower flame limit value is also called the Lower Explosive Limit (LEL), is the minimum limit of the concentration of fuel vapor in the air where if there is no source of fire, the gas will be burned. While the upper limit value or Upper Explosive Limit (UEL), which limits the maximum



1

Content from this work may be used under the terms of the [Creative Commons Attribution 3.0 licence](https://creativecommons.org/licenses/by/3.0/). Any further distribution of this work must maintain attribution to the author(s) and the title of the work, journal citation and DOI.

concentration of fuel vapor in the air where if there is no source of fire, the gas will be burned. Limit flame (Flammable Range) for propane is between 2.4% to 9.6%, while the butane between 1.9% to 8.6%. This means that for example, when a mixture of propane 2.4% with 97.6% air, then the mixture will be lit, but the amount of propane gas is a minimal amount. If the amount is less than 2.4% propane, the flame will not occur. And vice versa, if the amount is more than 9.6% propane also will not turn on, even though there are sources of ignition.

## 2. Fundamental theories

LPG (Liquefied Petroleum Gas) is made with gas, but for ease of distribution, LPG converted to a liquid phase by applying pressure. In liquid form, LPG is distributed in a tube or tank (Pertamina, 2012). The blast, which occurred on LPG gas cylinder caused by several factors such as leaks in tubing, valves, regulators, and accessories. In addition to not meet the standards, tools and supplies LPG gas tube was also damaged by the mixing activities from certain elements.

### 2.1. Gas Propane

Propane gas properties colorless, odorless, and flammable. This substance has a specific gravity of 1.56 and is heavier than air. An alkane series of hydrocarbons, with the formula  $C_3H_8$ . Made from crude oil, natural gas, and as a byproduct of the refinery cracking gases during petroleum refining. At higher temperatures, propane caught fire in the air, and produce carbon dioxide and water as end products. The atmosphere during combustion, occurs smoke production normally.

### 2.2. Butane Gas

This gas is colorless and has properties flammable. Butane has a specific gravity of 2.01 and is heavier than air. Butane is one of two hydrocarbon saturated with the chemical formula  $C_4H_{10}$ . In the n-butane (normal), the chain is continuous and unbranched whereas in i-butane (iso), one of the carbon atoms branched off to the side. Differences in the structure is small, but differ in terms of nature. N-butane melts at  $-138.3^\circ C$  ( $-216.9^\circ F$ ) and boils at  $-0.5^\circ C$  ( $31.1^\circ F$ ), and i-butane melts at  $-145^\circ C$  ( $-229^\circ F$ ) and boils at  $-10.2^\circ C$  ( $13.6^\circ F$ ). Both butane is formed from natural gas, petroleum, and gas refineries. They showed little chemical reactivity at ordinary temperatures, but it is easy to burn when ignited in air or oxygen. In the production of atmospheric combustion fumes.

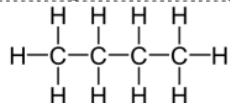

Figure 1. Propane Chemical Structure

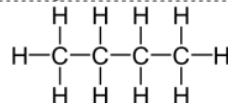

Figure 2. Butane Chemical Structure

### 2.3. LPG Gas Low Explosive Level

LPG gas leakage can occur through a hose connection that is not waterproof or the hose itself is porous pore so that it can be penetrated by a gas due to inadequate quality hose. This occurs through the valve of the tube itself that not fit on the stand or it could be like the writer ever experienced when cook gravy food that gone overflow, so as to put the fire in the stove. This causes the gas gush continue unchecked so that the gas fills kitchen.

In case of LPG gas leak in the kitchen, will be very dangerous because of the disadvantages that LPG is heavier than air. If the air is 1 per unit weight of the LPG, that means gas is 2 per unit weight.

The volume of gas may unexpectedly have accumulated and are in the explosive mixtures. LPG gas mixture to air up to 1.8% despite ignited or burned with a cigarette lighter flame that will not be an explosion or ignite. But at the gas content between 1.8% - 10%, it will explode very severe if there is no source of fire or electric static. In the LPG content of 10%, then it will only light up. That is because the nature of LPG gas mixture itself (SoehatmanRamli, 2005).

LPG explosion in the content of 1.8% - 10% are categorized perfectly, so it is very terrible destruction of the power mains, and also the blast power is depends on the amount of the mixture exploded. At the time of bursting, all of the oxygen in the area will be used up and becomes a vacuum, so that if there are people in the surrounding area, in addition got burns also be difficulty breathing. The surrounding buildings will bore the brunt of the air back and forth. **LPG exploded on**

the content of 1.8% to 10%, essentially was not followed by a fire. If followed by a fire means that the gas content is already 10% on (flammable) instead of an explosion.

#### 2.4. Fire

There is some definitions of fire, as follows:

1. Fire is uncontrolled flame beyond human ability and desire (Ramli, 2010).
  2. According to the Labor Department, fire is an exothermic oxidation reaction that progresses rapidly from a fuel accompanied by the emergence of fire or ignition (Wisaksono Department of Labour, 2011).
  3. Fire is a chemical reaction involving rapid oxidation (combustion) of fuel (Fire Risk UK).
- There are several theories that explain the fires, as follows:

##### a. Fire Triangle

According to this theory, fire occurred because of 3 factors into the fire element, namely:

- Fuel
- Heat source
- Oxygen

Fires can occur when all three elements of the fire is mutually react with each other (Ramli, 2010).

#### 2.5. Tetrahedron Theory

The fire triangle theory then developed into the theory tetrahedron where a fire could occur if there is a fourth element called a chain reaction. Without a combustion reaction, the fire will not be able to live constantly (Ramli, 2010).

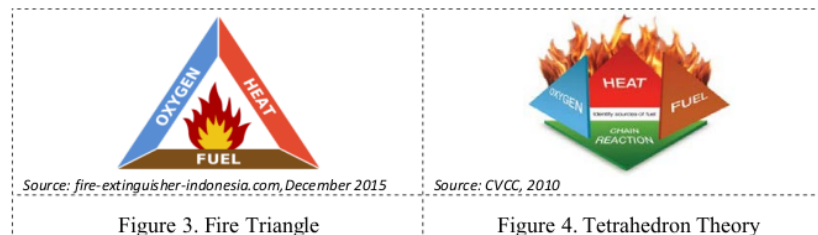

Figure 3. Fire Triangle

Figure 4. Tetrahedron Theory

#### 2.6. ATmega16 Microcontroller

Microprocessor technology has been progressing. The same thing happened on microcontroller technology. If the previous microprocessor technology *complex instruction-set computing (CISC)* processors such as the Intel 386/486, then the microcontroller ATMEGA uses types of MCS (AT89C51, AT89S51 and AT89S52).

After growing, technology microprocessors and microcontrollers to increase that occurred in the range of 1996 to 1998. ATMEGA issuing microcontroller technology the most manifold AVR (*Alf and Vegard's Risc processor*) technology that uses a RISC (*Reduce instruction Set Computer*) with the advantages of more than its predecessor.

Microcontroller ATmega16 is a low-power CMOS 8-bit microcontroller based on the AVR enhanced RISC architecture. With control of the execution of the instructions in a single clock cycle, ATmega16 approaches 1 MIPS per MHz allowing the system designed to optimize processing speed than what it uses to consume.

ATmega16 uses Harvard architecture with separate bus between the memories to maximize the ability and speed. Instructions in the program memory are executed with a *single level pipelining*.

When one instruction is executed, the next instruction is taken from the program memory. This concept led to the instructions executed in each *clock cycle*. CPU consists of 32 x 8 *general purpose registers* that can be accessed quickly in a single clock cycle, resulting in operation *Arithmetic Logic*

Unit (ALU) can be performed in a *single cycle*. In ALU operation, two operands come from the register, then the operation is executed and the results are stored back in the register in one clock cycle. Arithmetic and logic operation in ALU will change the bits that contained in *Status Register* (SREG). The process of taking instructions and executing instructions are running in parallel, and can be seen in the Figure below:

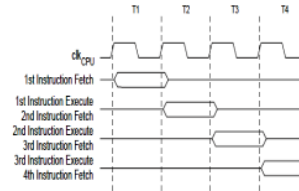

Figure 5. The Process of Taking Instructions and Executing Instructions in Parallel

### 2.7. LPG MQ-6 Sensor

To keep scanning the gas from LPG, ATmega16 microcontroller requires external devices such as an input device or a sensor input module LPG MQ-6. This sensor will read the content of LPG gas in the air.

MQ-6 has a sensor used to detect LPG, iso-butane, and propane with high sensitivity. MQ-6 gas sensor has a small sensitivity to a drug alcohol and cigarette smoke. MQ-6 gas sensor is a sensor that has a rapid response to the LPG. The sensor is also stable, durable, and can be used in a simple drive circuit.



Figure 6. LPG MQ-6 Gas Sensor

Source: [http://www.etlogics.com/LPG\\_Gas\\_Sensor\\_MQ-6.html](http://www.etlogics.com/LPG_Gas_Sensor_MQ-6.html), 2015

### 2.8. The ISIS Proteus 7 Professional Application

Proteus ISIS application is an electronic schematic creation program that can simulate circuit. Proteus ISIS program can also be used to design printed circuit boards (PCB). However, the writer only use Proteus ISIS as a maker of application circuit schematic and simulate it.

To use Proteus ISIS, it must be installed by following the installation prompts. How to use Proteus ISIS as follows:

- Run the application on the computer by selecting the application's shortcut or menu in Windows.
- Create a file by clicking "new design".
- Find the required key components in the button P.
- Arrange the components and create lines by connecting feet of components schema.

### 2.9. The PCB Wizard Application

The PCB Wizard Application is an application for designing printed circuit boards (PCB).

**3. Research method**

*3.1. Hardware Design*

Flowchart Research

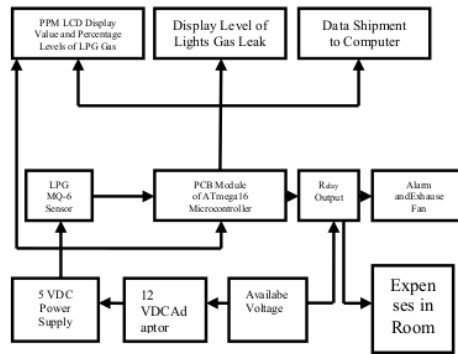

Figure 7. Flowchart Research

*3.2. Software Design*

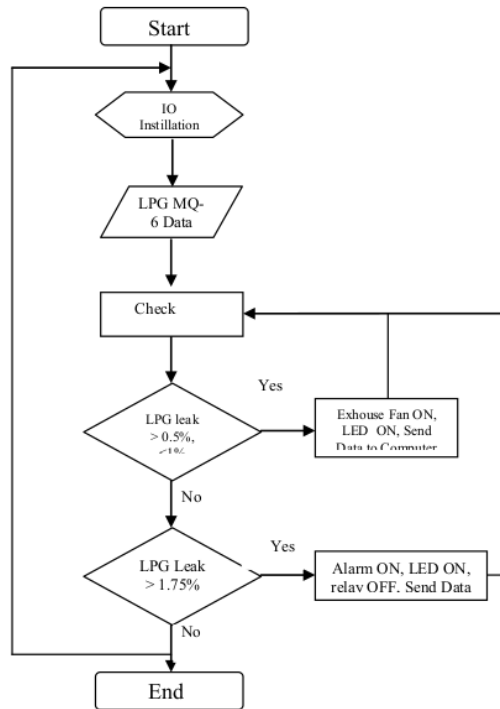

Figure 8. Software Design

**4. Result and analysis**

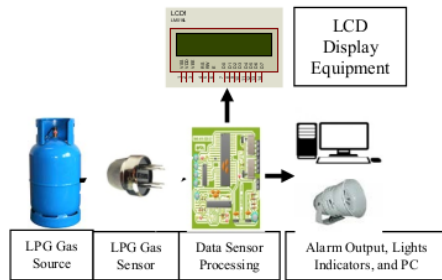

Figure 9. LPG Gas Detection Groove

LPG Gas scannings taken through the LPG (MQ-6) sensor data in the form of analog voltage is then converted into digital data 10 bit value from 0 to 1023. From this data, it will be the initial data to perform the calibration process that embedded within the microcontroller program ATmega16.

**1. PCB Designing**

PCB Designing uses PCB Wiz Application.

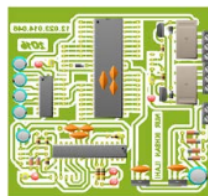

Figure 10. Component LLayouts and PCB Track

**2. Circuit Power Supply Testing**

Measurement aims to determine the power supply output voltage generated by the power supply, when it has no load and when connected to a load. It is also useful as a tool for sensor calibration calculations of MQ-6. Power supply is used to provide voltage to the sensor MQ-6, the minimum system microcontroller, and LED & LCD. From the results of 5 times tests, the result can be seen in the table.

The results of each output measured voltage when using a power supply load and no-load, that the value is found eligible for the supply voltage to the existing circuit. And measures can be seen in the Figure below.

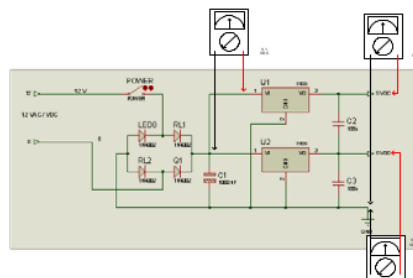

Figure 11. Power Supply Measurement

The Figure above is the power supply voltage measurement points that are entered into the circuit system. Measurement aims to determine whether good or bad the power supply to use.

**Table 1. Power Supply Measurement without Load**

Measurement	Voltage 1 (V1)	Voltage 2 (V2)	Voltage 3 (V3)
	Output DC	Output DC	Output DC
1	12,71	5,00	4,98
2	12,36	5,01	4,99
3	12,16	4,98	5,00
4	12,03	5,00	5,00
5	11,97	4,89	5,01

*Source: Primary Data, 2016*

The table above is a measurement table results without using a power supply load. The expenses in the form include sensors, LCD, microcontroller ATmega16, indicator lights, and relay output.

**Table 2. Power Supply Measurement with Load**

Measurement to	Voltage 1 (V1)	Voltage 2 (V2)	Voltage 3 (V3)
	Output AC	Output DC	Output DC
1	12,61	4,90	4,82
2	12,27	4,85	4,94
3	12,34	4,89	4,95
4	12,23	4,93	4,89
5	12,03	4,87	4,90

*Source: Primary Data, 2016*

The table above measurement table results using a power supply with a load, which aims to determine the voltage drop of the power supply, and to determine whether the power supply available to supply the used load.

**Table 3. Data Graph, Data Sheet**

No	Data from Data Sheet Graphic		Percent(%) LPG
	PPM	Rs / Ro	
1	200	2	0,02
2	300	1,8	0,03
3	400	1,6	0,04
4	500	1,5	0,05
5	600	1,4	0,06
6	700	1,3	0,07
7	800	1,2	0,08
8	900	1,1	0,09
9	1000	1	0,1
10	2000	0,75	0,2
11	3000	0,65	0,3
12	4000	0,56	0,4
13	5000	0,50	0,5
14	6000	0,48	0,6
15	7000	0,45	0,7
16	8000	0,43	0,8
17	9000	0,40	0,9
18	10000	0,30	1,0

*Source: Primary Data, 2016*

The data tables above represent primary data taken from the data sheet of LPG sensor MQ-6 which became the initial data to perform the calibration process sensors in the microcontroller program.

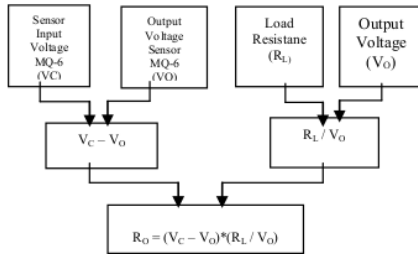
Searching for  $R_o$  value in clean airFigure 12. Searching for  $R_o$  Value in Clean Air

$$R_o = (V_c - V_o) * (R_L / V_o)$$

$$R_o = (4,84 - 0,35) * (20000 / 0,35)$$

$$R_o = (4,49) * (57142,85)$$

$$R_o = 256571,40 \Omega$$

$R_o$  is a sensor resistance value when the condition is worth  $R_s$  1000 ppm. The explanation of condition 1000 ppm is currently normal air conditions that is not mixed by propane gas and butane gas, because the state of 1000 ppm is the initial state or a minimum of  $R_s$  before detecting the levels of the gas, so that if the initial conditions, the  $R_L$  produced was 0.35 volts. Rated voltage of 0.35 volts taken from a minimum value issued by the sensor currently worth  $R_s$  1000 ppm.  $V_c$  formula is used to activate the circuit. Formula  $R_L$  is resistor used this tool to measure the  $R_L$  at 20K.

$R_o$  value has been obtained, that is 256,571.40  $\Omega$ , resulting from the  $R_o$  value can be used to find the value of  $R_s/R_o$ . With the value of  $R_s$ , the condition of the sensor can detect a wide variety of gas levels in air. Therefore, The Bascom Program states as follows:

$$R_o = 256571.40$$

$$Voltage = Gas\_ref/1023$$

$$Voltage = Voltage * 4.84$$

$$X = 4,84 - Voltage$$

$$Y = X / Voltage$$

$$R_s = Y * 20000$$

$$D = R_s / R_o$$

$D$  is value of  $R_s/R_o$  where the  $D$  value to be converted into the PPM via a conversion formula data from the data sheet that provides charts for LPG concentration in ppm against  $R_s/R_o$ , to the condition of 20 C and 65% RH. If it matches the curve to a given value, it was found that:

$$R_s/R_o = 18,446 * (ppm \text{ LPG})^{-0,421}$$

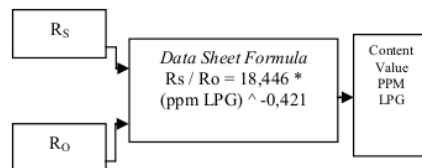

Figure 13. Sensor Calibaration

From the above conversion process, it was discovered the formula to change the value of the voltage that has been converted to  $R_s$  and  $R_o$  into PPM. The formula is as follows:

$$PpmLPG = [(R_s/R_o)/18,446]^{(1/-0,0421)}$$

In the Bascom program, AVR Rs/Ro is defined as variable D. And the result of the division between 24.83 to Rs/Ro defined as variables E. The following is how Bascom explains the formula.

$$D = Rs / Ro$$

$$E = D / 18,446$$

$$Ppm = E ^ (-2.375)$$

PPM levels have been obtained using a formula that is displayed on the LCD screen that to be calibrated again by adjusting the data sheet chart, whether or not formula display value of Rs/Ro compared with PPM gas levels as follows.

From the table above, it is found the increment ppm conduction chart data with the results of the calculation formula. Minimal difference between the value chart with the formula is 0.41% and the maximum difference of 5.87%. This was due to a lack of accuracy in the data collection charts. Means that the formula can be used in the calibration program but with the accuracy  $\pm 6\%$ .

### 3. Program Making

The program making will be embedded in the microcontroller using BASCOM-AVR and Khazama AVR application.

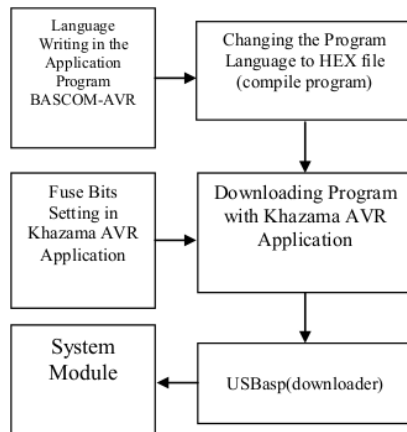

Figure 14. Charging Program of Microcontroller ATmega16

Table 4. Graphic Data and Formula Comparison

No	Data Graph Data Sheet		Data With Formula		Difference	Percent
	Rs / Ro	PPM	Rs / Ro	PPM		
1	2,00	200	2,00	195,691	4,30	2,15
2	1,70	300	1,70	287,873	12,13	4,04
3	1,50	400	1,50	387,526	12,47	3,11
4	1,35	500	1,35	497,708	2,29	0,46
5	1,25	600	1,25	597,526	2,47	0,41
6	1,17	700	1,17	699,159	0,84	0,12
7	1,10	800	1,10	809,487	9,49	1,19
8	1,05	900	1,05	904,052	4,05	0,45
9	1,00	1000	1,00	1015,121	15,12	1,50
10	0,75	2000	0,75	2010,237	10,23	0,51
11	0,65	3000	0,65	2823,895	176,11	5,87
12	0,56	4000	0,56	4023,196	23,20	0,57
13	0,50	5000	0,50	5265,795	265,80	5,32
14	0,48	6000	0,48	5801,894	198,11	3,30
15	0,45	7000	0,45	6762,979	237,02	3,39
16	0,42	8000	0,42	7967,107	32,89	0,41
17	0,40	9000	0,40	8945,925	54,07	0,60
18	0,38	10000	0,38	10104,890	104,89	1,05

### 4. Charging Program

Steps charging module using the application program to KHAZAMA AVR.

- Connect the USB cable to the module and computer.
- Open KHAZAMA AVR application.
- Select ATmega16 microcontroller.



Figure 15. Choosing the Type of Micorcontroller

### Operation of Equipment/System

The system works by detecting levels of LPG gas which is in the room source/engine using LPG gas. If there is a LPG gas is detected, the tool will first be issued the indicator of LPG PPM value on LCD, and if it increases, the leakage indicator light will turn on the appropriate level. Furthermore, leakage of data will be sent to the computer via Hyper Terminal and if the leak continues to rise, then try to flutter exhaust fan to reduce the levels of LPG in the room. However, if the LPG gas levels continue to rise and reach the threshold of explosive/fire, then the system will shut off the power source and exhaust fan, and also turn on the alarm.

3

### 5. Conclusion

Based on the result of design and research, it can be concluded as follows:

1. System tools have been successfully applied to the methods of reducing levels of gas in the room.
2. If the sensor detects the MQ-6 LPG gas at a certain level, the system displays on the computer, turn on the alarm, and turn off the power source.
3. Calibration sensor MQ-6 inserts into programming microcontroller ATmega16 for an accurate scanning.
4. A maximum load of alarm and exhousfan 1 A for 120V specified relay system output.

### Suggestion

Further suggestion:

1. Installation of equipment is carried out outdoors given the equipment is not immune to the explosion, as well as the equipment did not follow to die with the death of the power source in the room.
2. Installation of LPG gas sensor MQ-6 placed as close as possible to the source or sources of LPG gas is most vulnerable to leakage.
3. Use exhous fan larger for a big room.
4. Replace relay output for bigger output power use.

### References

- [1] <https://www.sparkfun.com/datasheets/Sensors/Biometric/MQ-6.pdf>, 2015), diakses Januari 2017.
- [2] Praveen Kumar , R. Kaushalendra Rao , N. Hemalatha Reddy, Sustained uptake of LPG as cleaner cooking fuel in rural India: Role of affordability, accessibility, and awareness, World Development Perspectives 4 (2016) 33–37
- [3] <https://www.wikiwand.com/id/Propana>, diakses Desember 2016.
- [4] <https://www.savvymicrocontrollersolutions.com/index.php?sensor=mq-gas-sensors>, diakses Desember 2016
- [5] Bambang Eko Soemarsono.1, Evi Listiasri1, Gilang Candra. (2015) *Early Detection*

- Equipment against LPG* JURNAL TELE Volume 13 Nomor 1 Edisi Maret 2015
- [6] Dian Sartika K. 2012. Consequential Analysis Of Gas Distribution, Fire, and Explosion due to 12 Kg LPG Tubes In the Manggarai Southware Village In 2012 By Using Breeze Incident Analyst Software . Final Project Report Published 2012. Universitas Indonesia
  - [7] Sidik Nurcahyo. (2012). *Aplikasi dan Teknik Pemrograman Mikrokontroler AVR Atmel*. Penerbit Andi
  - [8] AfricSetiawan.(2011) *20 Aplikasi mikrokontroler Atmega 8535 & Atmega 16 Menggunakan Bascom-AVR*. Penerbit Andi
  - [9] HeriAndrianto. (2008). *Pemrograman Mikrokontroler AVR Atmega16 Menggunakan Bahasa C (CodeVision AVR)*. Penerbit Informatika
  - [10] Z. Ning, T.L. Chan, On-road remote sensing of liquefied petroleum gas (LPG) vehicle emission measurement and emission factors estimation, *Atmospheric Environment* 41 (2007) 9099–9110
  - [11] Suhata, ST. 2005. *Aplikasi mikrokontroler sebagai Pengendali Peralatan Elektronik Via Line Telepon*. PT Elex Media Komputindo. Jakarta
  - [12] L.C. Shirvill, Efficacy of water spray protection against propane and butane jet fires impinging on LPG storage tanks, *Journal of Loss Prevention in the Process Industries* 17 (2004) 111–118

## ORIGINALITY REPORT

---

% **13**  
SIMILARITY INDEX

%  
INTERNET SOURCES

% **13**  
PUBLICATIONS

%  
STUDENT PAPERS

---

## PRIMARY SOURCES

---

**1** Tan Wei Yin, Sivakumar Ramakrishnan, Sheikh Abdul Rezan, Ahmad Fauzi Mohd Noor, Noor Izah Shoparwe, Reza Alizadeh, Parham Roohi. "Kinetic modeling of liquefied petroleum gas (LPG) reduction of titania in MATLAB", Journal of Physics: Conference Series, 2017 % **2**  
Publication

---

**2** "Physical Properties of Hydrocarbons", Handbook of Fire & Explosion Protection Engineering Principles for Oil Gas Chemical and Related Facilities, 1996 % **1**  
Publication

---

**3** Yuliarman Saragih, Jandoni Horas Prima Silaban, Hasna Aliya Roostiani, Agatha Elisabet S. "Design of Automatic Water Flood Control and Monitoring Systems in Reservoirs Based on Internet of Things (IoT)", 2020 3rd International Conference on Mechanical, Electronics, Computer, and Industrial Technology (MECnIT), 2020 % **1**  
Publication

---

4

Nikolaos Cristian Nutu, Constantin Pana, Niculae Negurescu, Alexandru Cernat, Ionel Mirica. "LPG as a Fuel for Diesel Engines- Experimental Investigations", IOP Conference Series: Materials Science and Engineering, 2017

Publication

% 1

5

Muhammad Irfan, Faizah Shahudin, VINCENT HOOPER, Waqar Akram, Rosmaiza Ghani. "The psychological impact of coronavirus on university students and its socio-economic determinants in Malaysia", Cold Spring Harbor Laboratory, 2020

Publication

% 1

6

Dennis P. Nolan. "Physical Properties of Hydrocarbons and Petrochemicals", Elsevier BV, 2019

Publication

% 1

7

Rajesh Singh, Shailesh Mishra. "Temperature monitoring in wireless sensor network using Zigbee transceiver module", 2010 International Conference on Power, Control and Embedded Systems, 2010

Publication

% 1

8

I Gusti Made Ngurah Desnanjaya, I Gede Iwan Sudipa. "The Control System of Kulkul Bali Based on Microcontroller", 2019 5th

% 1

# International Conference on New Media Studies (CONMEDIA), 2019

Publication

---

9

J Kaparuk, S Luft, T Skrzek, M Wojtyniak. "Some aspects of the CI engine modification aimed at operation on LPG with the application of spark ignition", IOP Conference Series: Materials Science and Engineering, 2016

Publication

---

% 1

10

Alexander Barkalov, Larysa Titarenko, Małgorzata Mazurkiewicz. "Chapter 3 Implementation of Computational Algorithms in Embedded Systems", Springer Science and Business Media LLC, 2019

Publication

---

% 1

11

N.H.A. Rahim, A.M. Kassim, M.F. Miskon, A.H. Azahar. "Effectiveness of central pattern generator model on developed one legged hopping robot", 2011 IEEE Student Conference on Research and Development, 2011

Publication

---

% 1

12

Aulia Akhrian Syahidi, Arifin Noor Asyikin, Asy'ari. "Applying Student Team Achievement Divisions (STAD) Model on Material of Basic Programme Branch Control Structure to Increase Activity and Student Result", IOP Conference Series: Materials Science and

% 1

## Engineering, 2018

Publication

---

13

Clifford N. Prescott. "LNG/LPG Subsea Loading Lines", Wiley, 2017

Publication

---

<% 1

14

Tsen Vui Hin, Nur Ilyani Ramli. "Design and Development of a Salbutamol Intake Detector for Low Respiratory Treatment", IOP Conference Series: Materials Science and Engineering, 2017

Publication

---

<% 1

15

Murnanda Zaesy Saputra, Dwi Aries Himawanto, Dominicus Danardono Dwi Prija Tjahjana, Titis Srimuda Pitana. "Combustion characteristics of Albizia Chinensis and Tectona Grandis sawdust and a mixture of both using thermogravimetry analysis", AIP Publishing, 2019

Publication

---

<% 1

16

S. Nivedhitha, A. P. Padmavathy, U. S. Susaritha, M. Ganesh Madhan. "Development of Multipurpose Gas Leakage and Fire Detector with Alarm System", 2013 Texas Instruments India Educators' Conference, 2013

Publication

---

<% 1

17

Carlos F. Gould, Johannes Urpelainen. "LPG as a clean cooking fuel: Adoption, use, and impact

<% 1

18

M. Irfan Fahmi, Jhonson Efendi Hutagalung.  
"Automatic Locker Key With Barcode Based  
Microcontroller Atmega 8535", Journal of  
Physics: Conference Series, 2017

Publication

---

<% 1

---

EXCLUDE QUOTES ON

EXCLUDE  
BIBLIOGRAPHY ON

EXCLUDE MATCHES < 5  
WORDS